



Officina
Portobello
C2

01

C2

Cucine

Componibili

Módulos em porcelanato se transformam em soluções versáteis de mobiliário para cozinhas.

Os componentes são personalizados de acordo com o estilo e o tamanho do projeto. Para a C2 – Cucine Componibili – utiliza-se o sistema de fixação Officina Portobello, composto de acordo com a estrutura necessária para segurança e resistência.

A escolha da superfície aliada ao acabamento de alta costura dos cortes em porcelanato, dão forma à elegância do ambiente.

A C2 representa a combinação perfeita de tecnologia projetual e rigor industrial para a realização de projetos únicos.

Bancada de cozinha C2
executada em Onyx Unique

C2 Kitchen countertop
executed in Onyx Unique

Bancada de cocina C2
ejecutada en Onyx Unique



C2 Cucine Componibili

Porcelain tile modules become versatile furnishing solutions for kitchens.

The components are customized according to the style and size of the project. For C2 - Cucine Componibili - we use the Officina Portobello fixing system, made according to the necessary structure for security and resistance.

The choice of the surface combined with the haute couture finish of the porcelain tiles shape the elegance of the area.

C2 represents the perfect combination of design technology and industrial rigor to carry out unique projects.

Bancada de cozinha C2
executada em MS. Barcelona Cristal
e Dansk Graphite 10mm

C2 Kitchen countertop
executed in MS. Barcelona Cristal
e Dansk Graphite 10mm

Bancada de cocina C2
ejecutada en MS. Barcelona Cristal
e Dansk Graphite 10mm



C2

Cucine Componibili

Módulos en porcelanato se convierten en soluciones versátiles de muebles para cocinas.

Los componentes se personalizan según el estilo y el tamaño del proyecto. Para C2 - Cucine Componibili - utilizamos el sistema de fijación Officina Portobello, compuesto según la estructura necesaria para seguridad y resistencia.

La elección de la superficie combinada con el acabado de alta costura de los cortes en porcelanato, dan forma a la elegancia del ambiente.

La C2 representa la combinación perfecta de tecnología de diseño y rigor industrial para la realización de proyectos únicos.

Bancada de cozinha C2
executada em Bianco di
Lucca 6mm

C2 Kitchen countertop
executed in Bianco di
Lucca 6mm

Bancada de cocina C2
ejecutada en Bianco di
Lucca 6mm



02

Formatos

Sizes

Formatos



Bancada de cozinha C2
executada em Onyx Unique

C2 Kitchen countertop
executed in Onyx Unique

Bancada de cocina C2
ejecutada en Onyx Unique

Soluções de Bancadas

Solutions in
countertops

Soluciones
para bancadas

Bancada de cozinha C2
executada em Concrete Rope

C2 Kitchen countertop
executed in Concrete Rope

Bancada de cocina C2
ejecutada en Concrete Rope



① **Tampo área úmida**
Wet area top
Tapa área húmeda

② **Tampo área seca**
Dry area top
Tapa área seca

③ **Frontão**
Edge return
Frontón

④ **Tampo duplo**
Double top
Tapa doble

⑤ **Fechamento frontal**
Front closure
Cierre frontal

⑥ **Pé duplo**
Double legs
Pie doble

⑦ **Rodapé**
Baseboard
Zócalo

⑧ **Pé simples**
Simple legs
Pie simple

⑨ **Saia**
Front edge
Falda

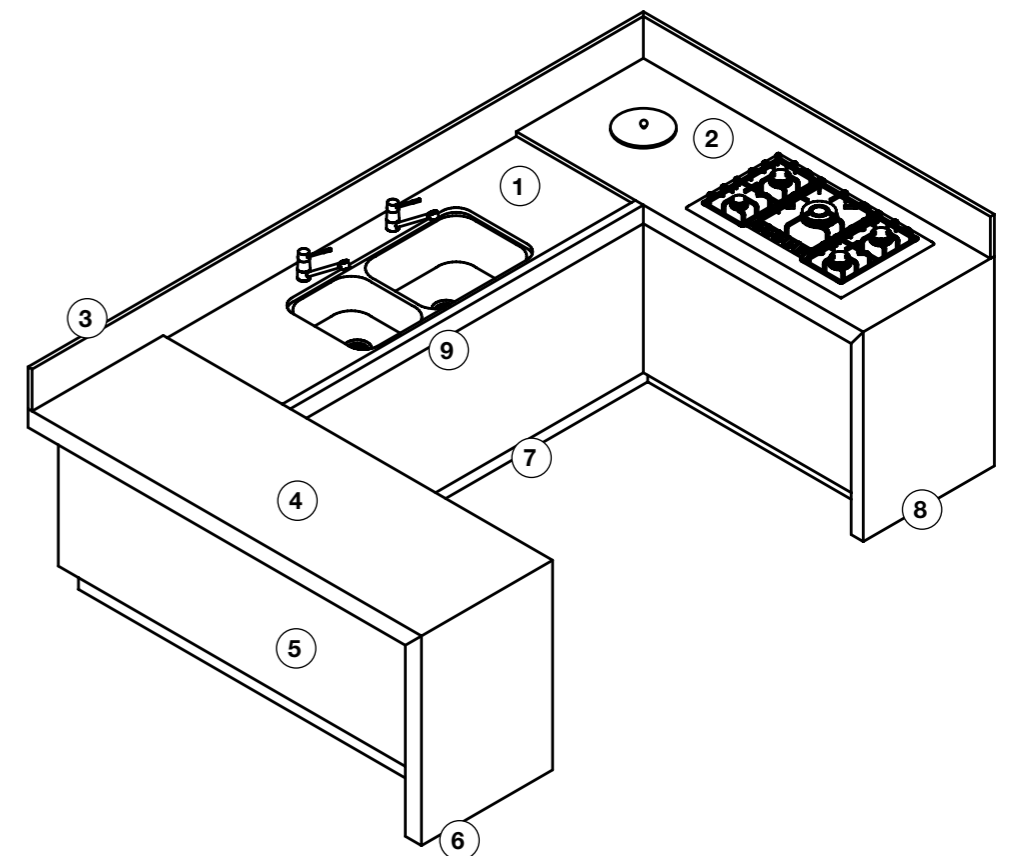

Soluções de Ilhas

Solutions to islands

Soluciones para islas

Bancada de cozinha C2 executada em Bianco di Lucca

C2 Kitchen countertop executed in Bianco di Lucca

Bancada de cocina C2 ejecutada en Bianco di Lucca



① **1, 2 ou 3 recortes para torneira**
1, 2 or 3 faucet cutouts
1, 2 o 3 cortes para grifo

② **Recorte para detergente**
Washing-up cutout
Recorte para detergente

③ **Recorte para área úmida**
Wet area cutout
Recorte para área húmeda

④ **Recortes para cuba**
Sink cutouts
Recortes para lavabo

⑤ **Recorte para lixeira**
Trash cutout
Recorte para basurero

⑥ **Bancada alta**
High countertop
Banco alto

⑦ **Fechamento**
Closure
Cierre

⑧ **Pés**
Legs
Pies

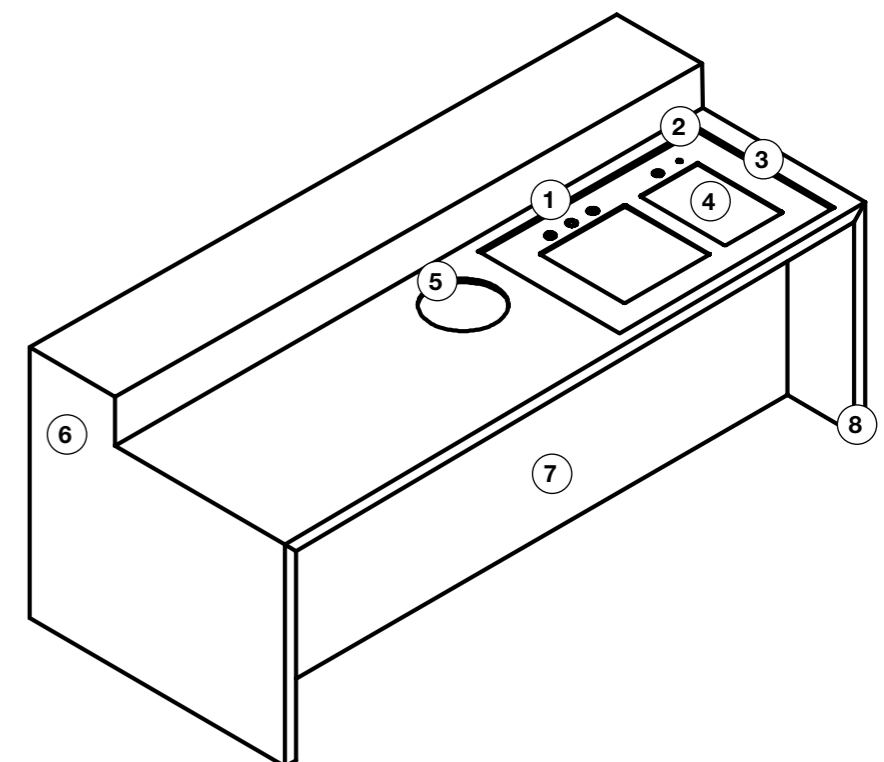

03

Atributos

Atributos | Atributos

Resistência: Reforços ocultos, maior resistência no uso aliado ao acabamento superior.

Resistance: concealed reinforcement, more resistance for use with superior finishing.

Resistencia: Refuerzos ocultos, mayor resistencia en el uso aliado al acabado superior..

Bancada de cozinha C2 executada em Travertino Navona Grigio

C2 Kitchen countertop executed in Travertino Navona Grigio

Bancada de cocina C2 ejecutada en Travertino Navona Grigio



Atributos

Atributes | Atributos

Personalize: Variedade de superfícies para compor o ambiente completo.

Personalize: Variety of surfaces to compose the entire space.

Personalice: Variedad de superficies para componer el ambiente completo.



Detalhes: Emendas e rebaixas com acabamento de alta costura.

Details: Mend and recess in high fashion finishing.

Detalles: Enmiendas y rebajes con acabado de alta costura.



Atributos

Atributes | Atributos

Backsplash flexível,
protege as paredes e
garante fácil manutenção.

Flexible backsplash, it protects
walls, and maintenance is easy.

Backsplash flexible, protege
las paredes y garantiza
un fácil mantenimiento.

Bancada de cozinha C2
executada em Bleu de Savoie

C2 Kitchen countertop
executed in Bleu de Savoie

Bancada de cocina C2
ejecutada en Bleu de Savoie



Atributos

Atributes | Atributos

MATERIAL INERTE

Inert material | Material Inerte



Produto Atóxico

Non-toxic product
Producto no toxico



Produto estéril
Zero Alergênicos

Sterile product
No Allergens

Producto estéril
Cero Alergênicos



MATERIAL IMPERMEÁVEL

Waterproof material | Material Impermeable



Não absorve Água -
Ideal para bancadas de
Cozinhas e Banheiros

It does not absorb water - ideal
for kitchen and bathroom benches

No absorbe agua - Ideal para
bancadas de Cocinas y Baños



Facilidade de Manutenção
e Limpeza com
Detergentes Neutro

Easy maintenance and cleaning
with neutral detergent

Facilidad de Manutención y limpieza
con Detergentes Neutros



Adequado para
Contato com
Alimentos

Suitable for contact
with food

Adecuado para Contacto
con Alimentos



Atributos

Atributes | Atributos

MATERIAL RESISTENTE

Resistent Material | Material Resistente



Alta Resistência Química
(não se altera com
produtos de limpeza)

High chemical resistance
(not altered by
cleaning products)

Alta Resistencia Química
(no sufre alteración con
productos de limpieza)

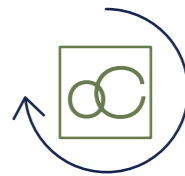

Composto por 70%
de Rochas Duríssimas
e Queimado a 1230°

Composed in 70% by hard
rocks, burnet at 1230 degrees

Composición de 70% de Rocas
muy duras y quemado a 1230°

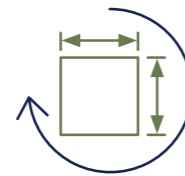

Estabilidade Dimensional
(medidas controladas
milimetricamente)

Dimensional stability
(dimensions controlled
by millimeter)

Estabilidad Dimensional
(medidas controladas
en milímetros)

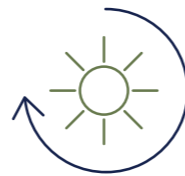

Não é danificado
por raios UVA e UVB

Not damaged by UVA
and UVB radiation

No es dañado por los
rayos UVA y UVB

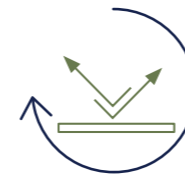

Altíssima Resistência
Mecânica

High mechanical resistance
Alta Resistencia Mecánica



Resistente ao
Choque Térmico

Resistant to thermal shock
Resistente al Choque Térmico



Resistente ao Fogo

Resistant to fire
Resistente al Fuego

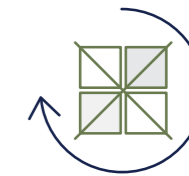

Não altera a Cor

It does not change color
Sin alteración de Color



04

Tabela Comparativa de Materiais e Usos

Comparison
of materials
and Uses

Comparativo
de Materiales

Bancada de cozinha C2
executada em Concrete Graphite





C2 Kitchen countertop
executed in Concrete Graphite

Bancada de cocina C2
ejecutada en Concrete Graphite

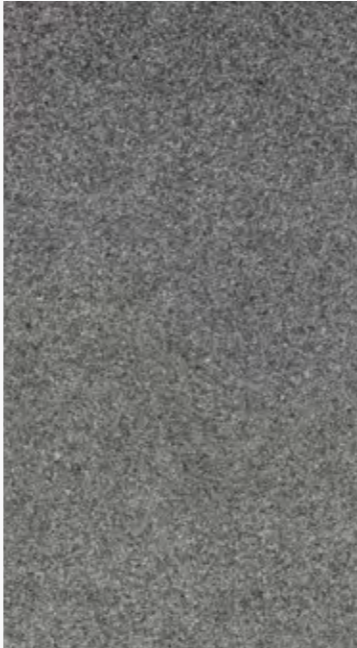
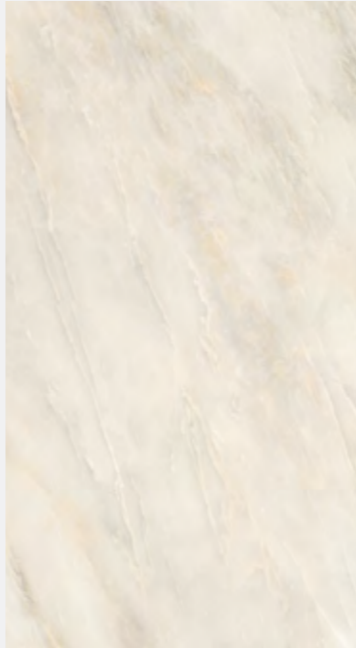

Tabela Comparativa de Materiais

Comparison of materials | Comparativo de Materiales

	PORCELANATO PORTOBELLO PORTOBELLO PORCELAIN TILES PORCELANATO PORTOBELLO	GRANITO GRANITE GRANITO	MÁRMORE MARBLE MÁRMOL	QUARTZO QUARTZ QUARZO	MADEIRA WOOD MADERA	SUPERFÍCIE SINTÉTICA SYNTHETIC SURFACE SUPERFICIE SINTÉTICA
POROSIDADE / ABSORÇÃO ÁGUA POROSITY / WATER ABSORPTION POROSIDAD / ABSORCIÓN DE AGUA	5	3	2	4	1	5
RESISTÊNCIA A MANCHAS RESISTANCE TO STAIN RESISTENCIA A MANCHAS	4	2	1	3	1	5
RESISTÊNCIA A RISCOS RESISTANCE TO RISKS RESISTENCIA A RAYADOS	2	2	2	2	2	1
RESISTÊNCIA A TEMPERATURA RESISTANCE TO TEMPERATURE RESISTENCIA A TEMPERATURA	5	4	3	2	2	1
RESISTÊNCIA A RAIOS UVA / UVB RESISTANCE TO UVA/UVB RADIATION RESISTENCIA A RAYOS UVA/UVB	5	4	4	2	1	1
HIGIENE E MANUTENÇÃO HYGIENE AND MAINTENANCE HIGIENE Y MANTENIMIENTO	5	3	3	4	1	4
RESISTÊNCIA A QUÍMICOS RESISTANCE TO CHEMICALS RESISTENCIA A QUÍMICOS	4	3	2	3	1	2
SUSTENTABILIDADE SUSTAINABILITY SUSTENTABILIDAD	5	1	1	3	1	3
						

Usos

Uses | Usos



Cozinha de uso cotidiano
Daily life kitchen | Cocina de uso cotidiano

Bancada Gourmet / Churrasqueira
Gourmet Bench / Grill | Encimera Gourmet / Área de parilla o barbacoa

- Durável**
 - Delicado**
- Durable Delicate
Durable Delicado

BRILHO GLOSS | BRILLO

Porcelanato Polido
Polished Porcelain Tile | Porcelanato Pulido



Porcelanato Natural
Natural Porcelain Tile | Porcelanato Natural



RESISTÊNCIA A MANCHAS RESISTANCE TO STAIN | RESISTENCIA A MANCHAS

Porcelanato Polido
Polished Porcelain Tile | Porcelanato Pulido



Porcelanato Natural
Natural Porcelain Tile | Porcelanato Natural



RESISTÊNCIA AO CALOR RESISTANCE TO HEAT | RESISTENCIA AL CALOR

Porcelanato Polido
Polished Porcelain Tile | Porcelanato Pulido



Porcelanato Natural
Natural Porcelain Tile | Porcelanato Natural



05

Acabamentos

Finishing | Acabados

Bancada de cozinha C2
executada em Still Now Sand

C2 Kitchen countertop
executed in Still Now Sand

Bancada de cocina C2
ejecutada en Still Now Sand



Acabamentos

Finishing | Acabados

Acabamento de borda

Edge finish | Acabado de borde

Borda
Edge | Borde

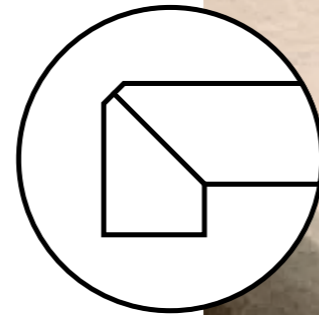

Nas composições de C2 utilizamos o acabamento de borda com Bisel. Este acabamento é responsável por oferecer maior resistência às bordas. Para a realização dos projetos da Cucini Componibili selecionamos bases com características Color Body que possibilitam uma integração perfeita do biselado à superfície da bancada.

In the C2 compositions we use the Bevel edge finish. This type of finish offer greater resistance to the edges. To carry out the Cucini Componibili projects, we selected bases with Color Body characteristics that allow a perfect integration of the bevel with the countertop surface.

En las composiciones C2 utilizamos el acabado de borde de bisel. Este acabado se encarga de ofrecer una mayor resistencia a los bordes. Para llevar a cabo los proyectos de Cucini Componibili, seleccionamos bases con características Color Body que permiten una perfecta integración del bisel con la superficie de la bancada.

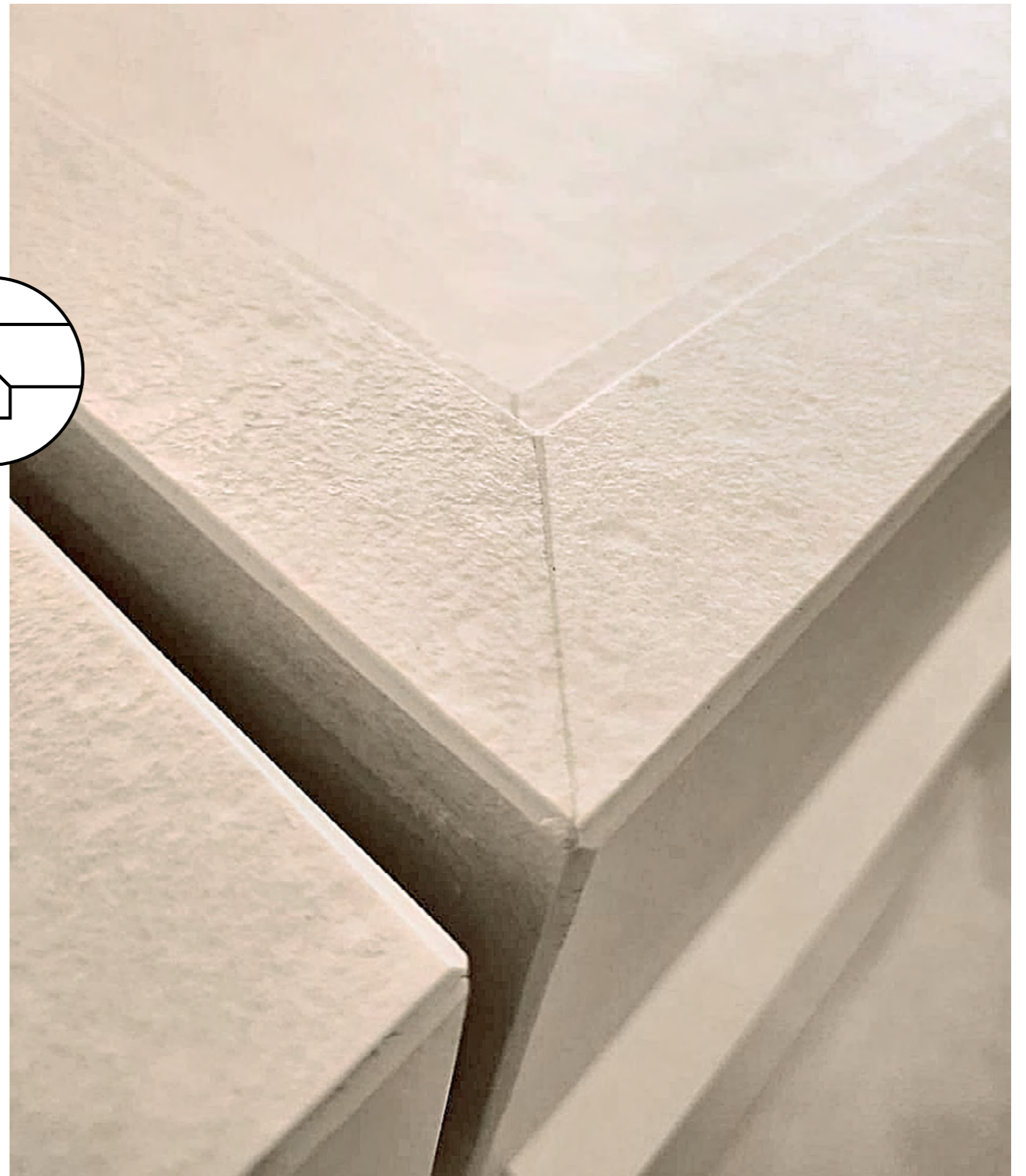

Bancada de cozinha C2 executada em Concrete White 6mm.
C2 Kitchen countertop executed in Concrete White 6mm.
Bancada de cocina C2 ejecutada en Concrete White 6mm.

Acabamentos

Finishing | Acabados

Natural (NAT)

Superfície plana e com toque acetinado, alcançado por um processo de escovas de metal que suavizam a superfície sem perder a opacidade.



Natural (NAT)

Flat surface with a satin touch, obtained after a process of metal brush which softens the surface without losing opacity.

Natural (NAT)

Superficie plana y con toque satinado, alcanzado por un proceso de cepillos de metal que suavizan la superficie sin perder la opacidad.

Acabamentos

Finishing | Acabados

Color Body

As lastras Portobello para porcelanateria são Full Body, ou seja, é um produto toda massa, com continuidade de cor entre massa e superfície, possibilitando bordas aparentes.

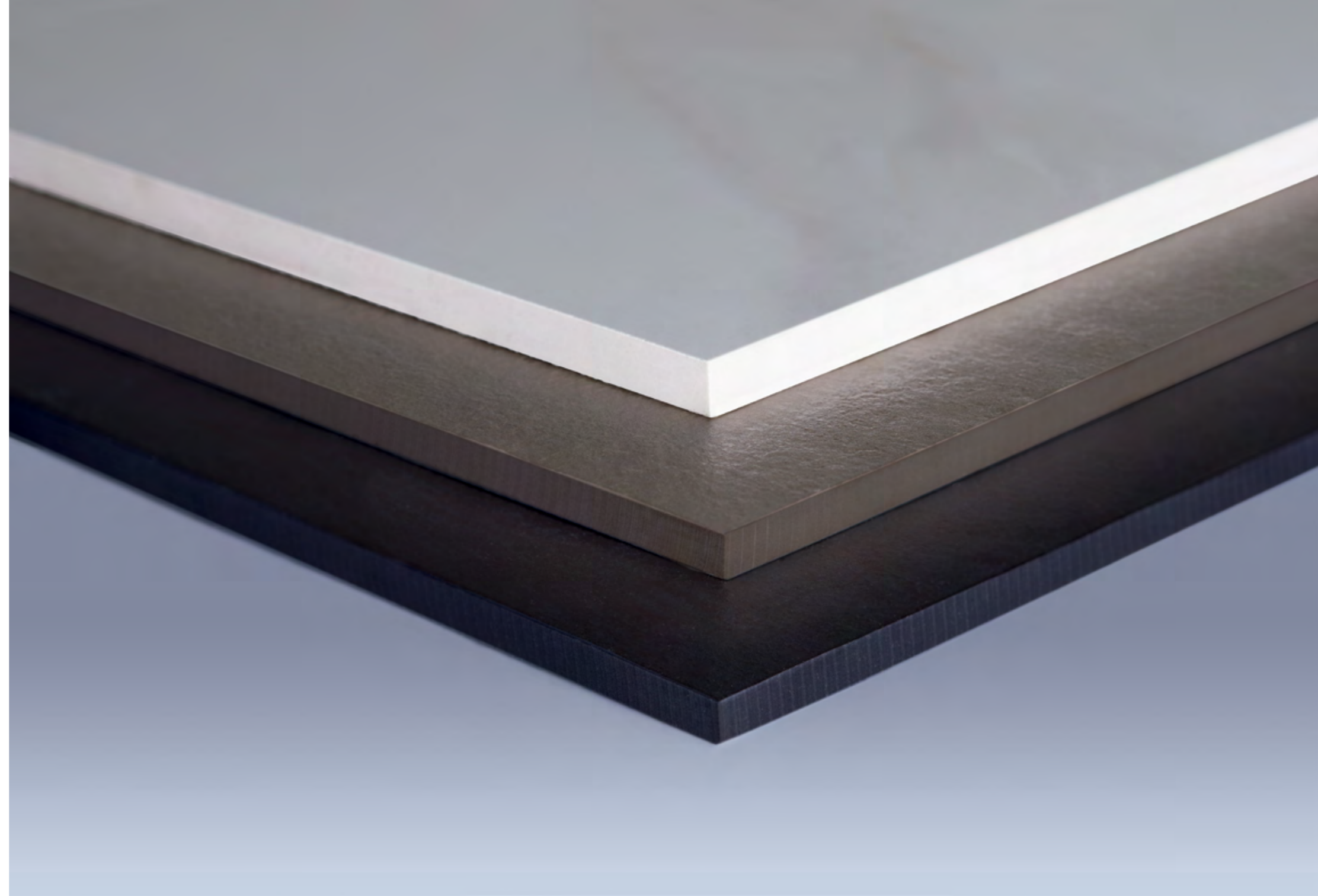

Color Body

Portobello slabs for porcelain tiles are full body, which means that there is continuity of color throughout the entire surface, making it possible to have apparent edges

Color Body

Las placas Portobello para porcelana son Full Body, o sea, es un producto todo masa, con continuidad de colores entre masa y superficie, posibilitando bordes aparentes.

Acabamentos

Finishing | Acabados

Dimensões

Dimensions | Dimensiones

Superfícies contínuas, as Lastras permitem projetos de mobiliário de grandes dimensões sem interrupções do desenho e de linhas de rejunte.

O controle industrial das medidas e dos desenhos garante precisão entre o planejamento e a execução dos mobiliários.

Continuous surfaces, slabs allow furniture projects to cover large dimensions without interruptions in the design and the use of grouting.

The industrial control of dimensions and design guarantees precision between planning and construction of furniture.

Superficies continuas, las Placas permiten proyectos de mobiliario de grandes dimensiones sin interrupciones del diseño y de líneas de rejunte.

El control industrial de las medidas y de los diseños asegura precisión entre la planificación y la ejecución de los mobiliarios.



Acabamentos

Finishing | Acabados

Espessura

Thickness | Espesor

Os produtos em nosso portfólio possuem espessura de 6mm, 10mm e 12mm.

The products in our portfolio have 6mm, 10mm and 12mm of thickness.

Los productos en nuestro portfolio poseen espesor de 6mm, 10mm e 12mm.

6mm



10mm



12mm

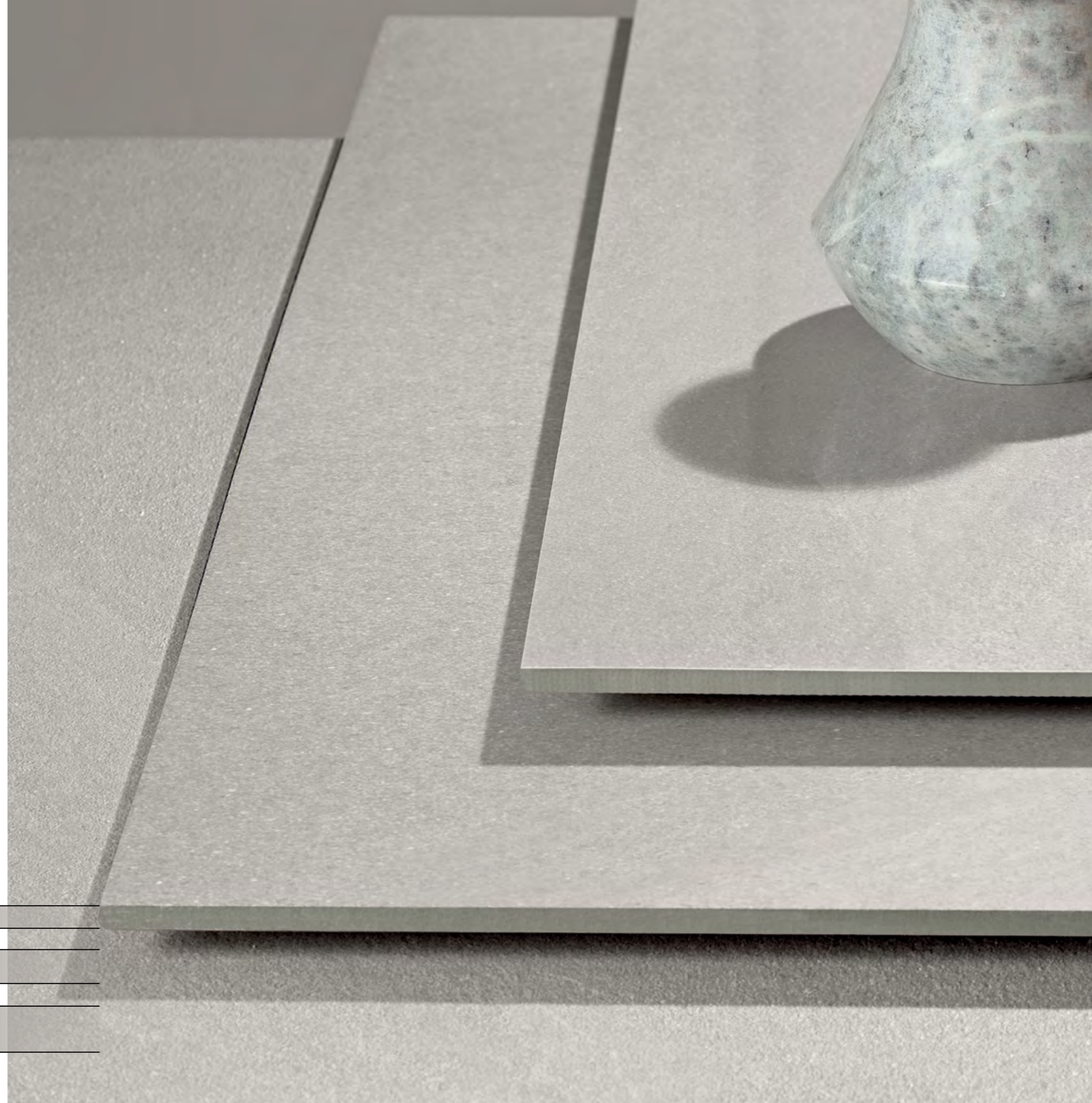

Bases

Bases | Bases



Tabela de Códigos de Bases

Bases Code Table | Tabla de códigos de Bases

Superfícies disponíveis para códigos finais da Serie C2

Surfaces available for end codes of C2 Series

Superfícies disponibles para códigos finales de la serie C2

Formatos	Espessura	Bianco Covelano NAT	Bianco Covelano POL	Bianco di Lucca NAT	Bianco di Lucca POL	Bianco Di Elba POL	Oro Bianco POL	Onyx Unique NAT	Onyx Unique POL	Rivoli POL	Classic Marquinia POL	Siena Chianti POL	Siena Pecorino POL	Araxá POL
														

90x180cm	10mm	200180E	12158E					200252E	12179E					
120x120cm	10mm	200882E	200837E			200813		200803E	200834E			200885	200806	200888
120x250cm	6mm													
120x260cm	6mm						28634			29571				
120x270cm	6mm							200004E	12178E		29931			
120x270cm	10mm	12985E	12984E	200135E	200113E									
120x278cm	6mm					26975								
160x320cm	12mm								29946E			29947		

1. Modelos com acabamento de molduras em meia esquadria.

1. Models with finishing frames miter.

1. Modelos con acabado de molduras a inglete

2. Modelos acabamento de moldura com massa Color Body aparente.

2. Models with finishing frames with apparent Color Body density

2. Modelos con acabado de moldura con densidad Color Body aparente

Bases

Bases | Bases





Tabela de Códigos de Bases

Bases Code Table | Tabla de códigos de Bases

Superfícies disponíveis para códigos finais da Serie C2

Surfaces available for end codes of C2 Series

Superfícies disponibles para códigos finales de la serie C2

Formatos	Espessura	Area White NAT	Area White POL	Area Black NAT	Dansk Cement White NAT	Dansk Cement Rope NAT	Dansk Cement Mud NAT	Dansk Cement Graphite NAT	Still Now Sand NAT	Ms. Barcelona Cristal NAT	Bleu De Savoie NAT	Posto 07 NAT	Mineral Off White NAT	Mineral Black NAT	Nordik Wood NAT
															

90x180cm	10mm									200187E					
120x120cm	10mm	200807E		200841E	200824E	200827E	200899E	200844E				200892	200895	200891	
120x250cm	6mm														
120x260cm	6mm														
120x270cm	6mm								29934		29933				
120x270cm	10mm	12991E	12990E		12983E	12982E	12981E	12980E							
120x278cm	6mm														
160x320cm	12mm								29945						29944

1. Modelos com acabamento de molduras em meia esquadria.

1. Models with finishing frames miter.

1. Modelos con acabado de molduras a inglete

2. Modelos acabamento de moldura com massa Color Body aparente.

2. Models with finishing frames with apparent Color Body density

2. Modelos con acabado de moldura con densidad Color Body aparente

Códigos

Codes | Codigos

Tabela de Códigos Modelo

Model Code Table | Tabla de códigos de Modelo

Superfícies disponíveis para códigos finais da Serie C2

Surfaces available for end codes of C2 Series

Superfícies disponibles para códigos finales de la serie C2

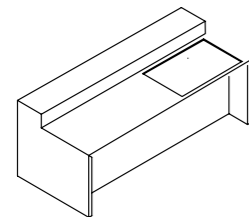
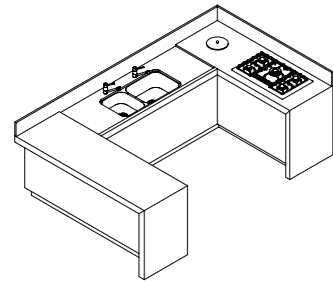

	Range	1 Parte	2 Partes	3 Partes	4 Partes	Ilha I	Ilha L	Ilha T	Ilha U
Bancada de Cozinha/ Lavanderia	Flexível	12723OF-M	12772OF-M	12773OF-M	12774OF-M				
Ilha	Flexível					12850OF-M	12853OF-M	12851OF-M	12852OF-M

1. Modelos com acabamento de molduras em meia esquadria.
1. Models with finishing frames miter.
1. Modelos con acabado de molduras a inglete

2. Modelos acabamento de moldura com massa Color Body aparente.
2. Models with finishing frames with apparent Color Body density
2. Modelos con acabado de moldura con densidad Color Body aparente

Officina
Portobello

Officina Portobello todos os direitos reservados.
Officina Portobello all rights reserved.
Officina Portobello todos los derechos reservados.

www.portobello.com.br